

# MobileCorder

Paperless Recorder with FTP, E-mail Sending, and Web Monitoring Functions

# MV100/MV200



- MV100 (12 channels max.) and MV200 (30 channels max.) added to data logger line-up
- 5.5-inch (MV100) / 10.4-inch (MV200), wide viewing-angle, TFT color LCD for better viewability
  - Removable storage on 3.5-inch floppy disk, Zip disk, or CompactFlash memory card
    - Data collection over Ethernet network (standard)
    - E-mail sending function and Web monitoring function
      - Network-compatible sophisticated software
      - Highly reliable hardware

# Paperless Recorder with FTP, E-mail Sending, and Web Monitoring Functions

## MobileCorder MV 100/MV 200

(12 channels max.)

(30 channels max.)

### Large-capacity recording memory

The MV100/MV200's internal memory can store approximately 27 hours of continuous data when recording at 1-second intervals with a 6-channel model, or 8 hours when using a 20-channel model\*. Data capacity can be increased to approximately 1.1 years' worth of continuous data at the same recording interval with a 6-channel model, and 4.1 months' with a 20-channel model by using a CompactFlash memory card as a removable storage medium.

\*: 20-channel model available only for the MV200.

### Advanced network capability

The MV100/MV200 is standard equipped with an Ethernet (10BASE-T) port for high-speed communications. The Ethernet capability makes it possible to form a simple network of PCs and MV100/MV200 units using a hub, or connect the MV100/MV200 to a LAN.

### E-mail and Web monitoring

E-mail sending and Web server functions are standard features on the MobileCorder, making it easy to set up a remote data monitoring environment.

### Application software

The standard application software includes data display functions and MV100/MV200 setting functions. Optional software (sold separately) is also available with more advanced networking capabilities (e.g., file transfers and data monitoring).

### MobileCorder MV100/MV200

The MobileCorder is an innovative paperless recorder designed by Yokogawa for today's networked-data environment. Equipped with a wide-viewing-angle TFT color display, Ethernet port, and removable storage media (floppy disks, CompactFlash memory card, and Zip disks), this data logger can be used as a standalone unit or in a networked environment.



**MV100**  
MobileCorder

**MV200**  
MobileCorder

#### MV100

2-channel model: 125 ms measurement interval  
4-channel model: 125 ms measurement interval  
6-channel model: 1 second measurement interval\*  
12-channel model: 1 second measurement interval\*  
(\*: Measurement interval is 2 seconds when the A/D integrating time is set to 100 ms.)

#### MV200

4-channel model: 125 ms measurement interval  
8-channel model: 125 ms measurement interval  
10-channel model: 1 second measurement interval\*  
20-channel model: 1 second measurement interval\*  
30-channel model: 1 second measurement interval\*  
(\*: Measurement interval is 2 seconds when the A/D integrating time is set to 100 ms.)

#### Specifications Common to MV100/MV200

**Removable storage medium:** 3 options (3.5-inch floppy disk, Zip disk, CompactFlash memory card)

**Inputs:** DC voltages, thermocouples, resistance temperature detectors, and digital inputs can be mixed.

### Networked data logging and monitoring with MV

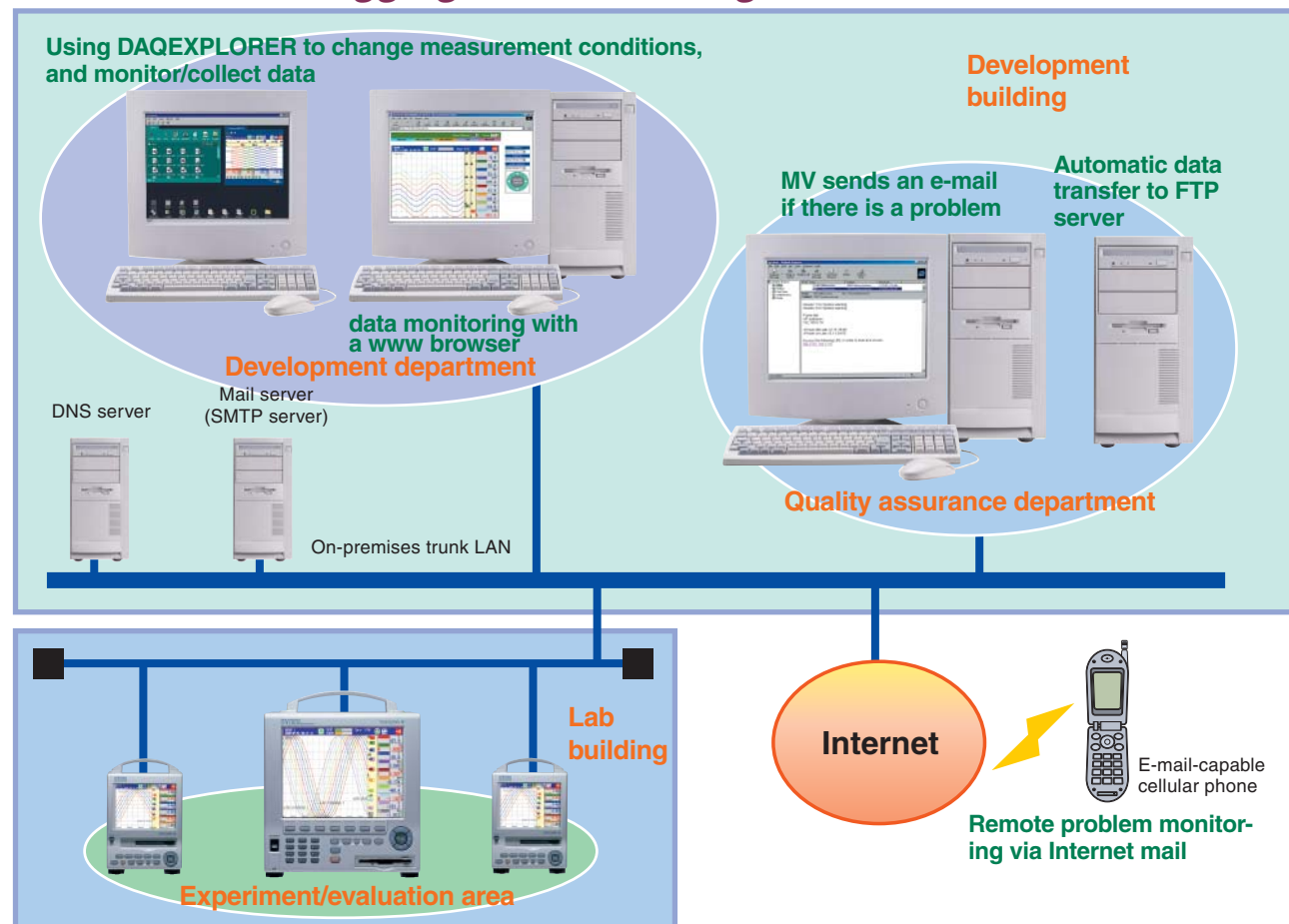

### Web monitoring

#### Displaying MV screen data on a www browser

MV screen data can be displayed on a www browser (Microsoft Internet Explorer 5.0/5.5). When screen auto-update mode is selected on the browser, the MV screen on the browser is automatically updated every 30 seconds. The user can also change the MV screen display type (trend display, digital display, bar graph display, historical trend display, etc.) and display groups, and enter messages through the browser. The MV Web server function makes it easy to set up a remote monitoring environment with zero startup costs.

Displaying the MV screen on a www browser

**A variety of monitoring functions**

Example address <http://192.168.0.10/operator.htm>

The screen display type and display groups can be changed here.

**Trend display**

**Digital display**

**Message input function**

Messages can be input to the MV screen from a browser screen.

**MV screen**

Messages can be input remotely.

**Alarm information display**

Displays the most recent 120 events.

**All-channel display**

Displays instantaneous values and alarm statuses for all channels.

**History display**

Displays the history for errors, communication, FTP, e-mail use, Web use, and messages.

1	1.4	33.8
2	28.5	125.7
3	35.2	100.0
4	257.1	581.2

### E-mail function

#### Periodic instantaneous values, alarm information, and other information can be transmitted from MV via e-mail.

MV can transmit the following data via e-mail – alarm notification messages, power-restoration messages following an outage, memory-full messages, storage-media-full messages, periodic instantaneous values, report data, and other information. Multiple recipients can be registered.

When connected to the Internet, MV can send e-mail anywhere in the world. An e-mail-capable cellular phone can be used to receive instantaneous remote notification of alarms.

```
Sender: MV200@xxx.xx.xx
Recipient: xx@xxx.xx.xx
Subject: [MV] Alarm_summary
```

```
Alarm summary
<IP address>
192.168.0.1
```

```
<CH>02
<Type>1H
<On>01/01 02:06:35
<Off>01/01 02:06:38
```

```
<Inst. value>
01/01 02:06:38
01=26.6 °C
02=29.6 °C
03=-0.479 V
04=-0.482 V
05=-0.515 V
```

Received e-mail (example)

#### Sending e-mail using an existing mail system

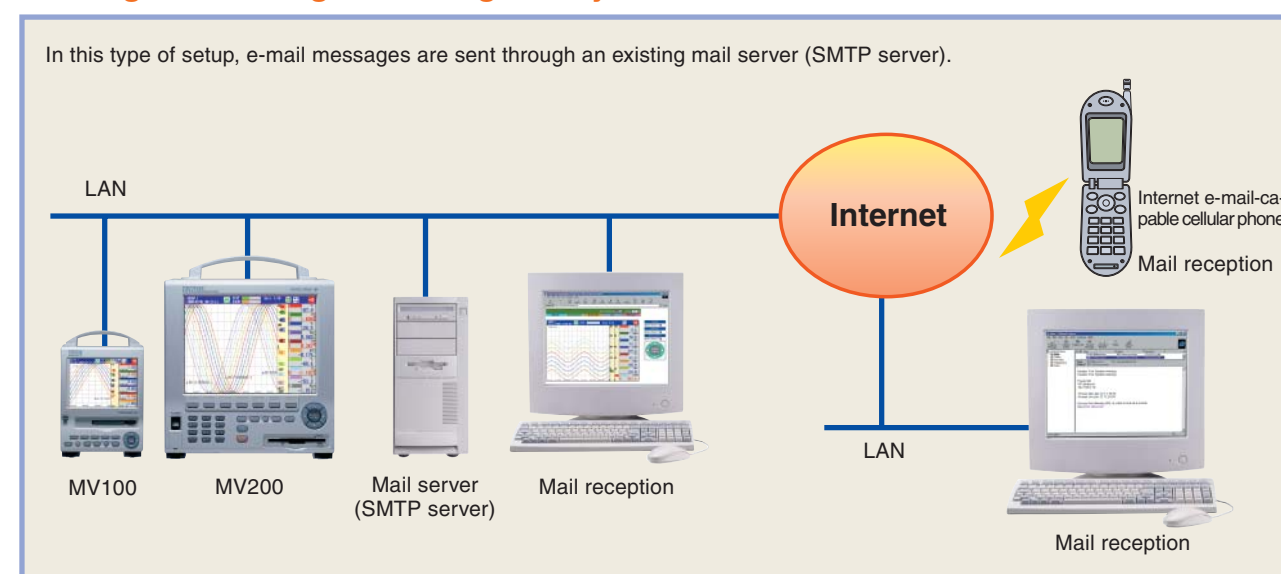

#### Sending e-mail from a remote site with no existing mail system

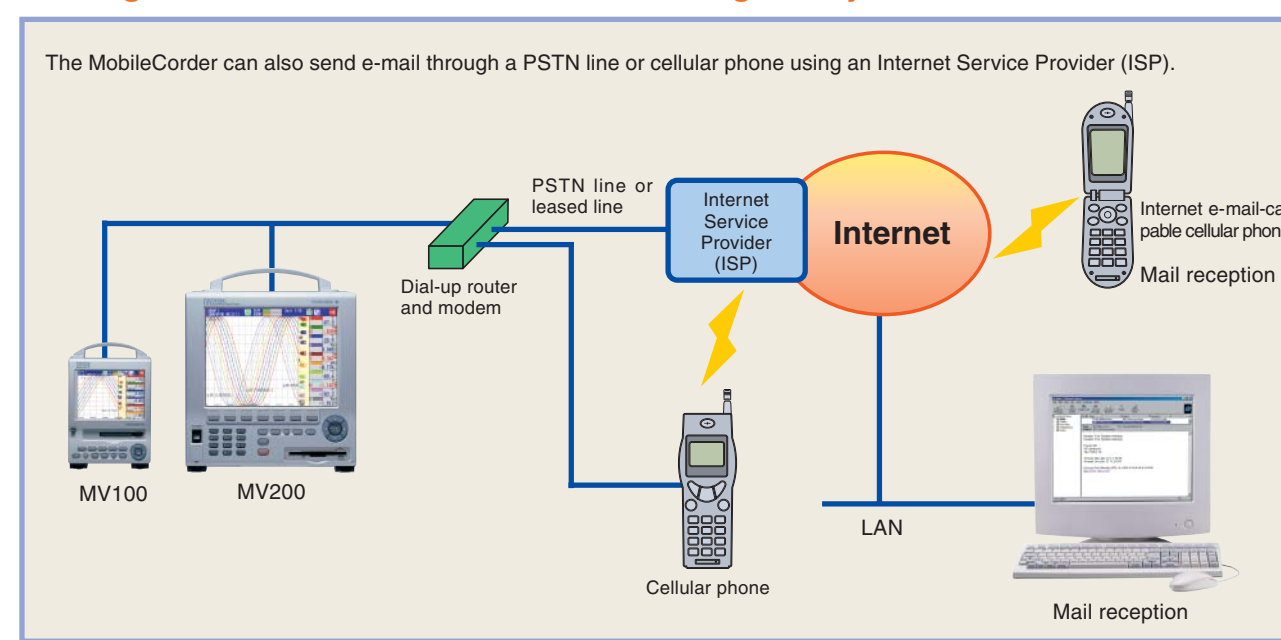

FTP function

FTP client function

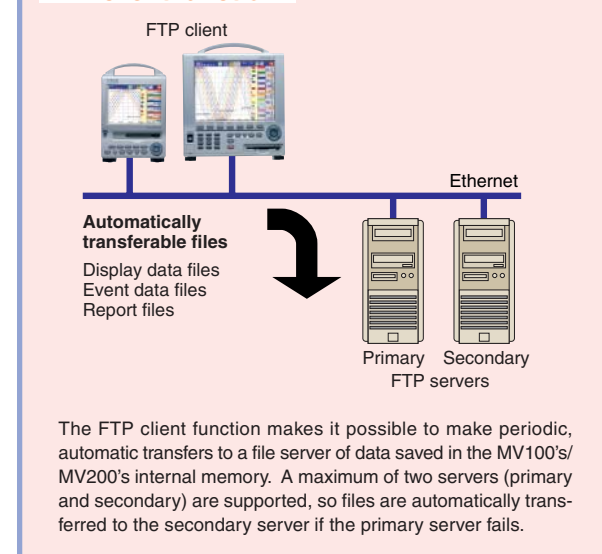

FTP server function

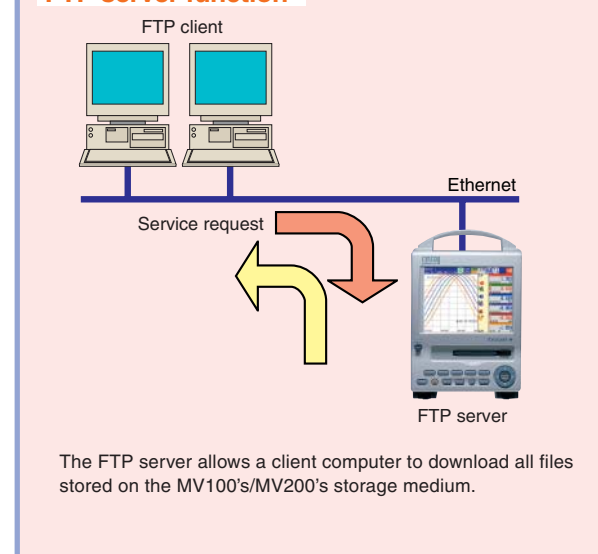

Network capabilities through Ethernet

PC direct connection

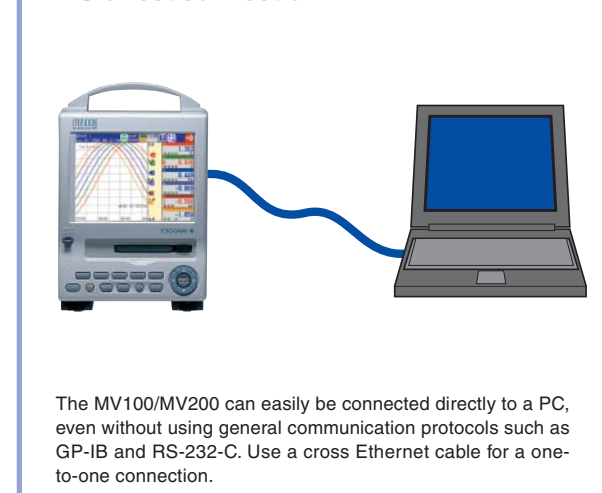

Simple network

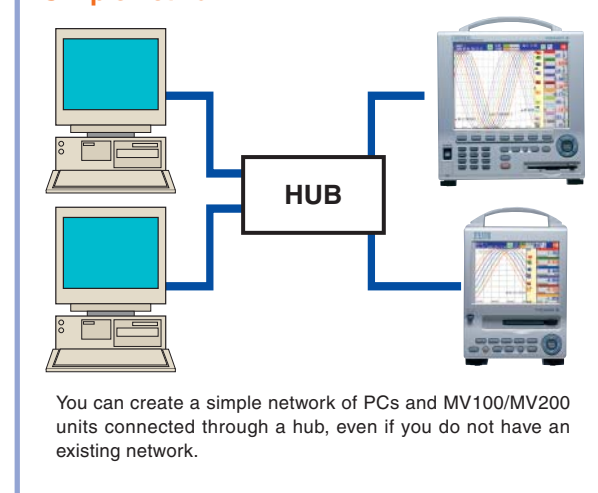

LAN network connection

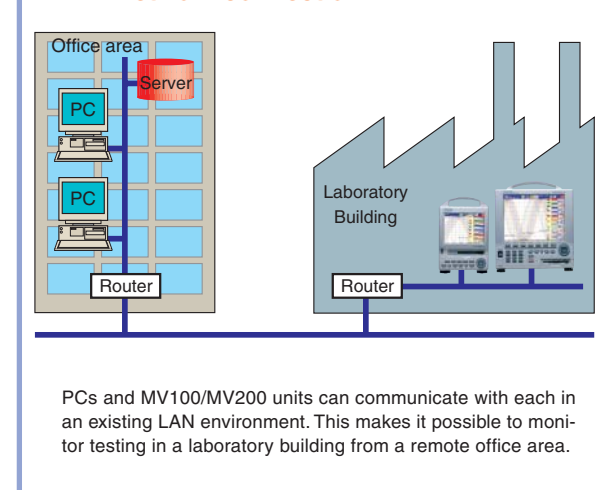

PSTN network connection

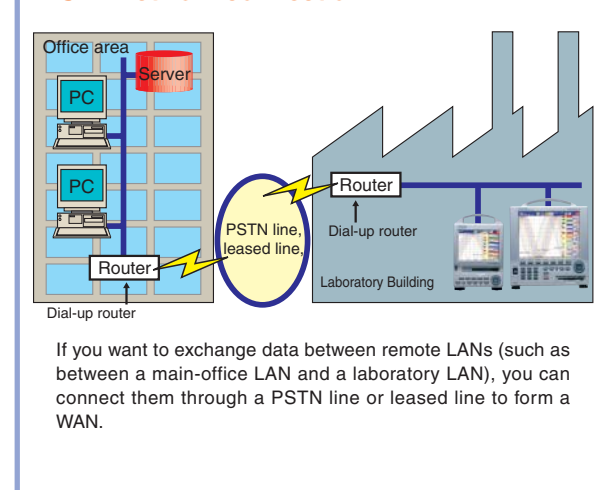

Trend display (simultaneous display of all channels possible)

Displays the scale values and engineering unit for each channel and arbitrary messages, along with the waveforms. The orientation (vertical/horizontal) of the trend display and background color (white/black) can be switched. The fastest trend display update rate is 15 sec/div (approximately 2376 mm/h in terms of display speed) for a 125-ms measurement interval model.

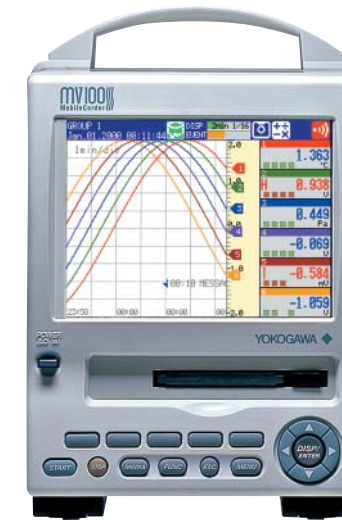

MV100 (5.5-inch display)

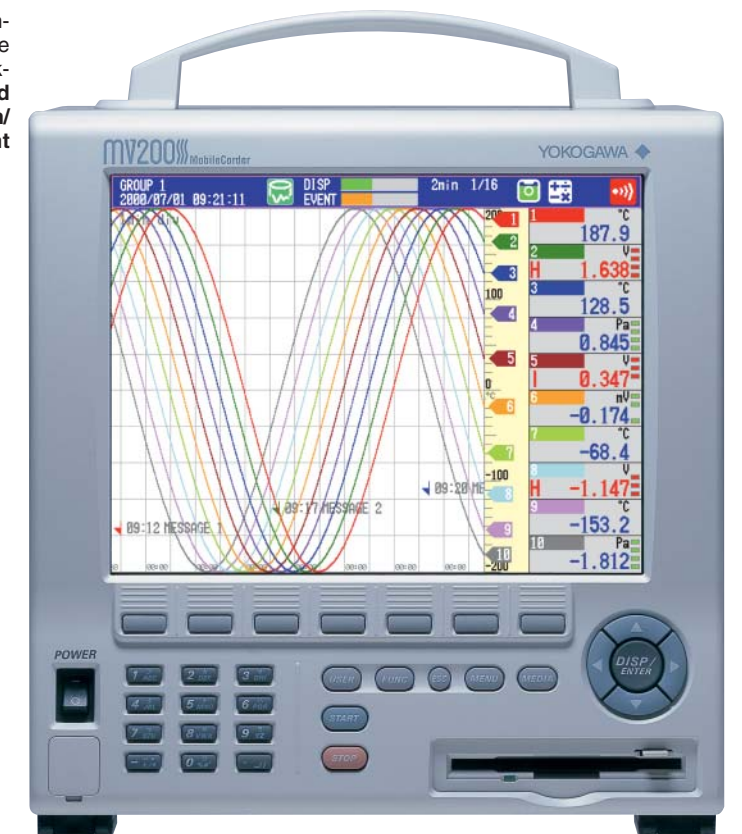

MV200 (10.4-inch display)

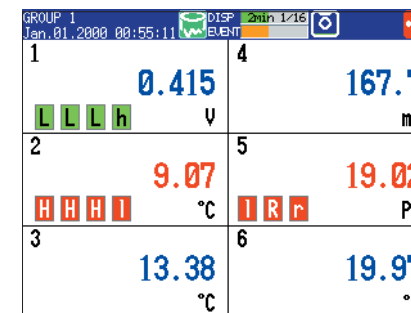

**Digital display (group switching display)**  
Displays digital measurements, as well as channel/tag numbers, engineering units, and alarm statuses.

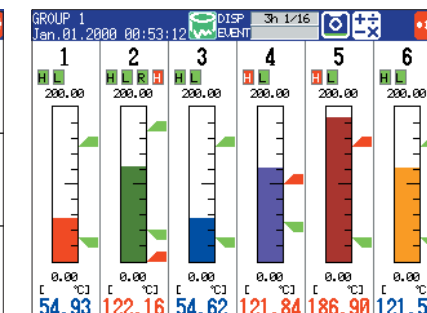

**Bar graph display (group switching display)**  
Vertical and horizontal bar graphs can be selected.

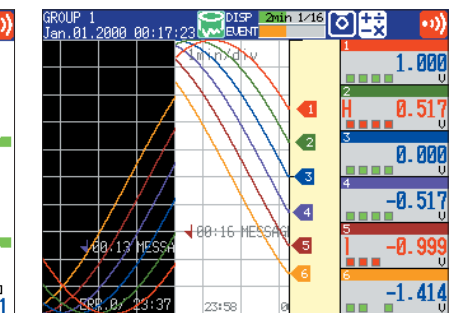

**Historical trend display**  
Allows past data saved in memory to be played back. In addition, historical and current trends can be viewed at the same time.

1	7	31	37
2	8	32	38
3	9	33	39
4	10	34	40
5	11	35	41
6	12	36	42

**Overview display**  
Allows digital readings and alarm statuses on all channels (including calculation channels) to be monitored.

Channel	Time	Alarm IN Time	Alarm OUT Time
21	Jan.01 00:14:55	Jan.01 00:14:44	
21	Jan.01 00:14:24	Jan.01 00:14:13	
21	Jan.01 00:13:53	Jan.01 00:13:42	
21	Jan.01 00:13:22	Jan.01 00:13:11	
21	Jan.01 00:12:51	Jan.01 00:12:40	
21	Jan.01 00:12:20	Jan.01 00:12:09	
21	Jan.01 00:11:49	Jan.01 00:11:38	
21	Jan.01 00:11:18	Jan.01 00:11:07	
21	Jan.01 00:10:47	Jan.01 00:10:36	
21	Jan.01 00:09:45	Jan.01 00:09:34	
21	Jan.01 00:09:14	Jan.01 00:09:03	
21	Jan.01 00:08:43	Jan.01 00:08:32	
21	Jan.01 00:08:12	Jan.01 00:08:01	
21	Jan.01 00:07:41	Jan.01 00:07:30	
21	Jan.01 00:07:10	Jan.01 00:06:59	
21	Jan.01 00:06:39	Jan.01 00:06:28	
21	Jan.01 00:06:08	Jan.01 00:05:57	
21	Jan.01 00:05:37	Jan.01 00:05:26	
21	Jan.01 00:05:06	Jan.01 00:04:55	

**Information display**  
Displays an alarm summary, message summary, and report data.

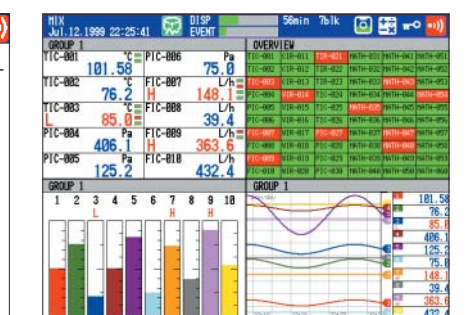

**4-split screen (MV200 only)**  
The display can be divided into 4 screens for any display type.

## Reliable data storage in internal memory

The MV100/MV200 saves measurement data in internal memory. Data in internal memory can also be transferred to PCs or data servers either online or using a removable storage medium. The measurement data memory consists of nonvolatile flash memory (1.2 MB) that does not require a battery backup. This means data written to memory will not be lost due to events such as a power outage.

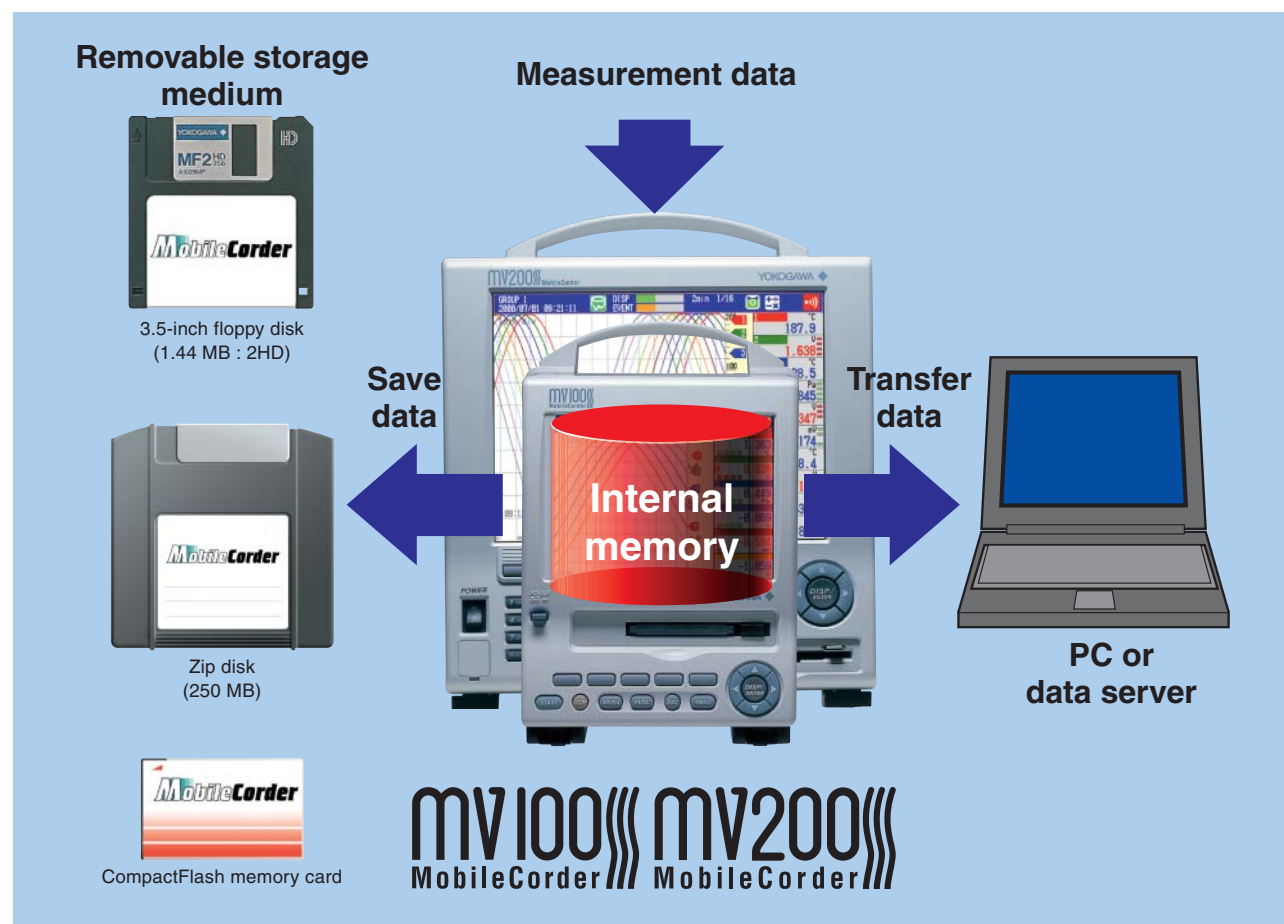

## Simultaneous extended-period data storage and detailed analysis

### Measurement data

The MV100/MV200 can save data in two formats (display data and event data).

### Display data—for extended-period trend recording

The display data format is used to save data displayed as waveforms. Each time the waveform display is updated, two data values (maximum and minimum values) measured since the previous update are saved.

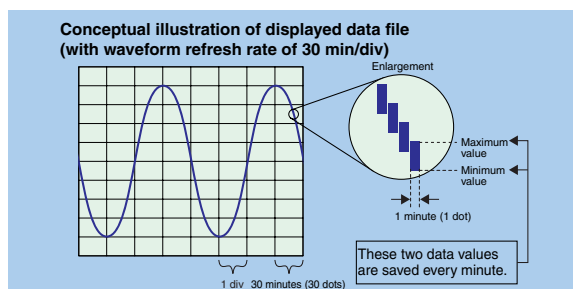

### Event data—for detailed analysis

The event data format is used to save all data in a specified data saving interval. Event data can be used in combination with the trigger functions to detect and analyze abnormal data.

A pretrigger can also be set, making it possible to analyze data before and after the trigger.

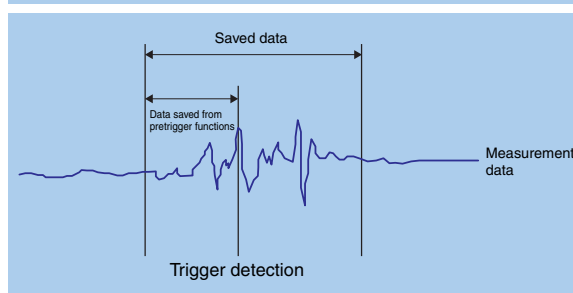

### File structure

The two data formats can be used in combinations such as the following:

- 1 Display data only
- 2 Event data only
- 3 Display data and event data in combination

Display data, event data, and a trigger function can be used in combination. With this approach, display data with a slow sample rate can be used for continuous extended-period recording, and event data with a faster sample rate can be used to record short-term details.

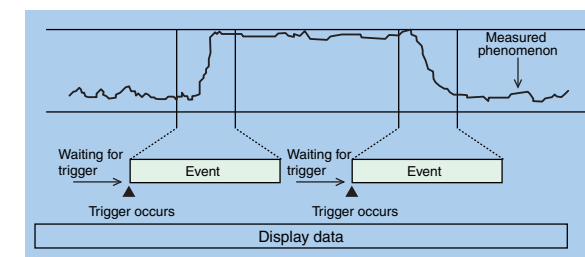

### Other data

In addition to measurement data, the MV100/MV200 can also save the following types of data:

- Manual sampling data: Instantaneous values (the 50 most recent measurements) occurring at each contact input or key input are saved in ASCII format.
- Time-series (TLOG) calculation data: Maximum value, minimum value, integrated (totalized) value, etc. during fixed interval (with calculation option)
- Report data: Hourly reports, daily reports, weekly reports, monthly reports (with calculation option)
- Settings data: Settings for set mode and setup mode

## Extended-period data saving

### 1. Saving data to internal memory

The tables below present examples of the maximum internal memory data saving times.

Event data file only (no calculation channel)

Measurement channels	Saving interval			
	125 ms	500 ms	1 second	10 seconds
2	Approximately 4.1 hours	Approximately 16.6 hours	Approximately 33.3 hours	Approximately 13.8 days
4	Approximately 4.1 hours	Approximately 16.6 hours	Approximately 33.3 hours	Approximately 13.8 days
6	—	—	Approximately 27.7 hours	Approximately 11.5 days
12	—	—	Approximately 13.8 hours	Approximately 5.7 days

Event data file only (no calculation channel)

Measurement channels	Saving interval			
	125 ms	500 ms	1 second	10 seconds
4	Approximately 4.1 hours	Approximately 16.6 hours	Approximately 33.3 hours	Approximately 13.8 days
8	Approximately 2.6 hours	Approximately 10.4 hours	Approximately 20.8 hours	Approximately 8.6 days
10	—	—	Approximately 16.6 hours	Approximately 6.9 days
20	—	—	Approximately 8.3 hours	Approximately 3.4 days
30	—	—	Approximately 5.5 hours	Approximately 2.3 days

Display data file only (no calculation channel)

Measurement channels	Display updating interval (min/div)					
	Saving interval					
	15 seconds	1 minute	2 minutes	5 minutes	30 minutes	
2	Approximately 13.8 hours	Approximately 2.3 days	Approximately 4.6 days	Approximately 11.5 days	Approximately 69.4 days	
4	Approximately 10.4 hours	Approximately 1.7 days	Approximately 3.4 days	Approximately 8.6 days	Approximately 52 days	
6	—	Approximately 1.1 days	Approximately 2.3 days	Approximately 5.7 days	Approximately 34.7 days	
12	—	Approximately 13.8 hours	Approximately 1.1 days	Approximately 2.8 days	Approximately 17.3 days	

Display data file only (no calculation channel)

Measurement channels	Display updating interval (min/div)					
	Saving interval					
	15 seconds	1 minute	2 minutes	5 minutes	30 minutes	
4	Approximately 10.4 hours	Approximately 1.7 days	Approximately 3.4 days	Approximately 8.6 days	Approximately 52 days	
8	Approximately 5.2 hours	Approximately 1.7 days	Approximately 3.4 days	Approximately 4.3 days	Approximately 26 days	
10	—	Approximately 16.6 hours	Approximately 1.3 days	Approximately 3.4 days	Approximately 20.8 days	
20	—	Approximately 8.3 hours	Approximately 16.6 hours	Approximately 1.7 days	Approximately 10.4 days	
30	—	Approximately 5.5 hours	Approximately 11.1 hours	Approximately 1.1 days	Approximately 6.9 days	

### 2. Saving data to removable storage medium

MV100/MV200 data are saved as files to a removable storage medium.

The tables below present examples of the maximum data saving times for a CompactFlash memory card.

Event data file only (no calculation channel)

Measurement channels	Saving interval			
	125 ms	500 ms	1 second	10 seconds
2	Approximately 10.2 months	Approximately 4.1 years	Approximately 8.2 years	Approximately 17.4 years
4	Approximately 5.1 months	Approximately 2.1 years	Approximately 4.1 years	Approximately 8.7 years
6	—	Approximately 1.1 years	Approximately 2.3 years	Approximately 4.6 years
12	—	Approximately 211 days	Approximately 1.1 years	Approximately 2.9 years

Event data file only (no calculation channel)

Measurement channels	Saving interval			
	125 ms	500 ms	1 second	10 seconds
4	Approximately 2.4 months	Approximately 10.2 months	Approximately 1.7 years	Approximately 17.4 years
8	Approximately 1.2 months	Approximately 5.1 months	Approximately 10.2 months	Approximately 8.7 years
10	—	—	Approximately 10.2 months	Approximately 6.9 years
20	—	—	Approximately 4.1 months	Approximately 3.4 years
30	—	—	Approximately 2.7 months	Approximately 2.3 years

Display data file only (no calculation channel)

Measurement channels	Display updating interval (min/div)					
	Saving interval					
	0.5 second	2 seconds	4 seconds	10 seconds	1 minute	
2	Approximately 10.2 months	Approximately 3.4 years	Approximately 6.8 years	Approximately 17.4 years	Approximately 104.4 years	
4	Approximately 5.1 months	Approximately 1.7 years	Approximately 3.4 years	Approximately 8.7 years	Approximately 52.2 years	
6	—	Approximately 1.1 years	Approximately 2.3 years	Approximately 4.6 years	Approximately 29.1 years	
12	—	Approximately 211 days	Approximately 1.1 years	Approximately 2.9 years	Approximately 17.4 years	

Display data file only (no calculation channel)

Measurement channels	Display updating interval (min/div)					
	Saving interval					
	0.5 second	2 seconds	4 seconds	10 seconds	1 minute	
4	Approximately 5.1 months	Approximately 1.7 years	Approximately 3.4 years	Approximately 8.7 years	Approximately 52.2 years	
8	Approximately 2.5 months	Approximately 1.7 years	Approximately 3.4 years	Approximately 4.3 years	Approximately 26.1 years	
10	—	Approximately 8.2 months	Approximately 1.3 years	Approximately 3.4 years	Approximately 20.9 years	
20	—	Approximately 4.1 months	Approximately 8.2 months	Approximately 1.7 years	Approximately 10.4 years	
30	—	Approximately 2.7 months	Approximately 5.4 months	Approximately 1.1 years	Approximately 6.9 years	

**DAQSTANDARD** (for Windows 98/Me/NT4.0/2000/XP, MV100/MV200 standard software)

● **Data Viewer**

Data Viewer can be used to redisplay or convert the format of binary data files saved with the MV100/MV200 (event data, display data, and TLOG data files), as well as binary data files transferred to a file server via FTP or other means (event data, display data, and TLOG data files). MV100/MV200 data files can be converted to ASCII format or the formats of shrinkwrap spreadsheet programs (Lotus 1-2-3 and Microsoft Excel). Data Viewer can also display text files (e.g., report files and manual sample files). Lastly, Data Viewer includes a file-linking function (for displaying, as linked data, contiguous data saved in multiple files).

● **Configuration Software**

The configuration software can be used to enter various MV100/MV200 configurations either online or using a removable medium.

**DAQEXPLORER** (for Windows 98/Me/NT4.0/2000/XP) (sold separately)

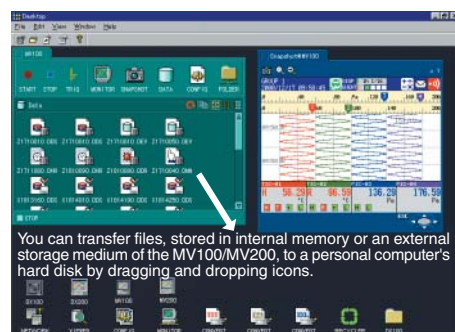

**Support for data monitoring and file transfer in a networked environment**

● **Desktop**

Desktop integrates DAQEXPLORER functions.

Main features:

- (1) Searches for and mounts MV100/MV200 units distributed on a network.
- (2) Activates the data monitor, data viewer, and configuration software.
- (3) Starts/stops recording and triggers on the MV100/MV200.
- (4) Prints out the MV100/MV200 display.
- (5) Lists files stored in internal memory and an external storage medium.
- (6) Transfers data files automatically.
- (7) Transfers data files manually (by dragging and dropping icons).

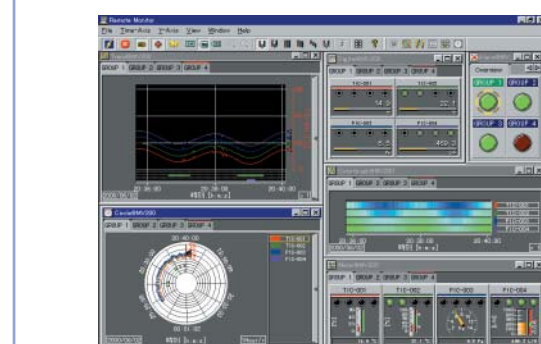

● **Data Monitor**

Used to monitor measurement data in various formats. It also allows monitoring of measurements from MV100/MV200 units mounted on DAQEXPLORER desktops running on other personal computers.

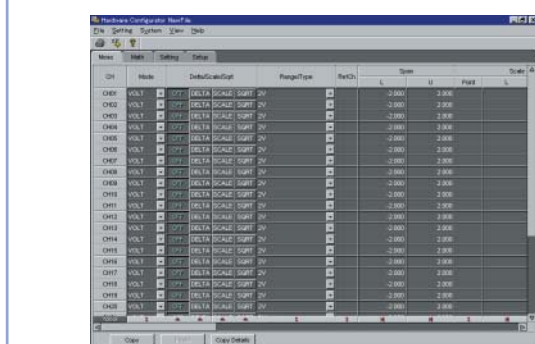

● **Configuration Software**

The Configuration software is used to exchange settings between a PC and the MV100/MV200. This program can be used to make all settings related to the MV100/MV200, other than communications-related settings (e.g., IP address).



● **Data Viewer**

The Data Viewer software displays, in a variety of formats, display data files (.dds), event data files (.dev), and TLOG files (.dtg) generated by the MV100/MV200. It can also display, as linked data, contiguous data saved in multiple files. Data Viewer can also be used to convert binary data files to ASCII, Excel, and Lotus 1-2-3, and to display text files (e.g., report files and manual sample files).

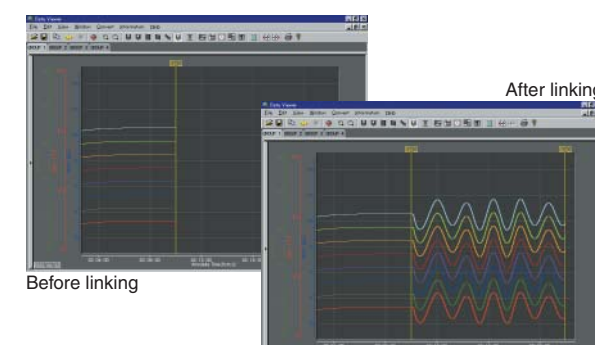

● **Linked File Display (by Data Viewer)**

Data files automatically generated by breaking up contiguous data into multiple files in the MV100/MV200 can be displayed as linked files. You can save the file linking conditions, making it easy to redisplay linked files. In addition, displayed linked files allow you to read values, perform interval arithmetic, and convert data to ASCII or MS-Excel/Lotus 1-2-3 format.

● **DAQEXPLORER Optional Module (XF1, automatic conversion to Excel, Lotus 1-2-3, or ASCII format)**

This optional module lets the user create separate data collection folders for each MV unit, and can automatically convert data to Excel, Lotus 1-2-3, or ASCII format when saved in a folder.

**DAQLOGGER** (Windows 98/NT4.0/2000/XP) (sold separately)

**Multi-channel real-time data logging software**

DAQLOGGER integrates up to 1600 data acquisition channels from as many as 32 recorders connected in a multi-drop configuration through Ethernet and serial links (RS-232-C/RS-422-A). The configuration may include a mixture of MobileCorder MV Series units,  $\mu$ R and VR recorders, DAQSTATION DX Series units, and DARWIN data acquisition units. Because DAQLOGGER supports multiple ports, the system configuration can combine RS-422-A, RS-232-C, and Ethernet links.

DAQLOGGER requires no user programming. Once the equipment is connected, you just need to enter the required settings and then you're ready to start collecting data. As many as 16 client PCs on Ethernet links can remotely access DAQLOGGER during data collection via a server PC for remote data monitoring. DAQLOGGER Client software needs to be installed on accessing client PCs.

DAQLOGGER also supports Internet applications. It lets you send e-mail messages (which may include binary file attachments) and transfer binary files (FTP client) to specified addresses at a set time or when an event occurs such as an alarm or file creation.

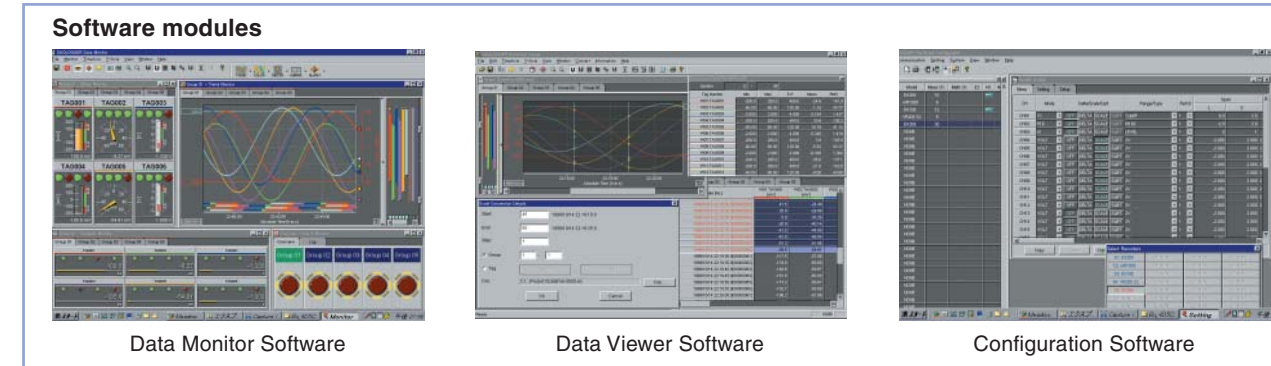
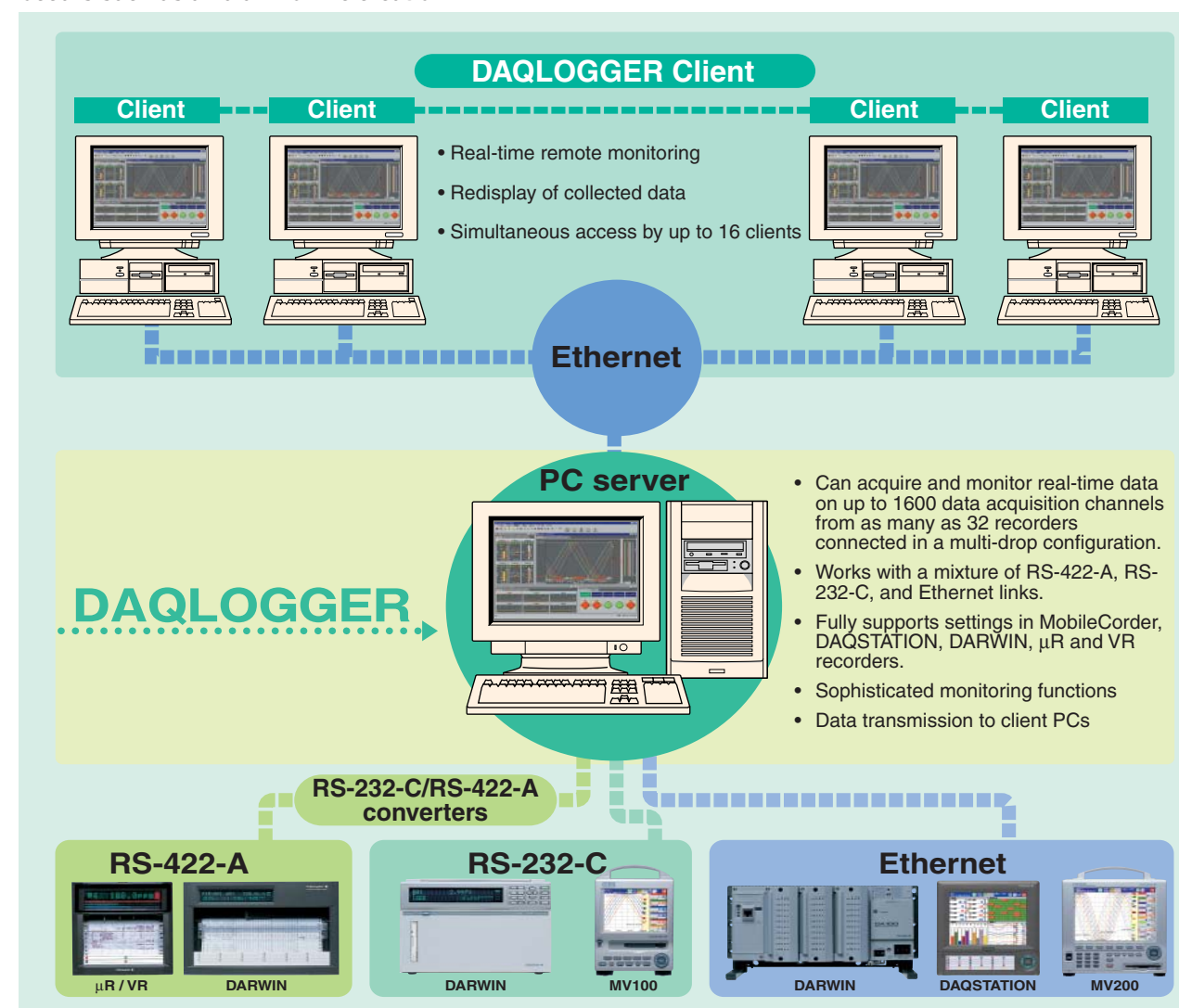

## Connecting MV and DARWIN (Modbus master function, /C3/M1, /C2/M1)

The number of MV inputs can be increased. MV can be used to monitor DARWIN measurement data.

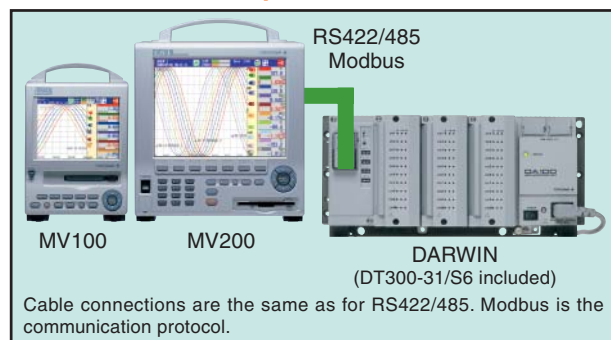

The MV Modbus master function and DARWIN Modbus slave function can be used to assign DARWIN input channels to MV calculation channels. (The number of assignable DARWIN channels is equal to the number of MV calculation channels.)

This capability makes it possible to increase the number of MV inputs. On the DARWIN side, this is beneficial in making it possible to monitor data through MV, and to save data to MV. Of course, it is also possible to use networked MV applications (e.g., DAQEXPLORER, Web server) for DARWIN data acquisition and monitoring.

Use of this function requires an RS-422-A/485 communications interface (/C3) and calculation module (/M1).

Note: An RS-232/RS-422-A converter is required for Modbus connections of MV and DARWIN units with options /C2 and /M1.

## OPC Server

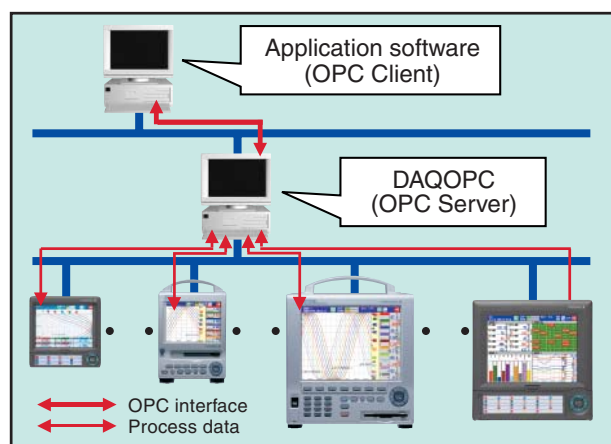

DAQOPC is an interface package compliant with the OPC specification (OLE for Process Control), which is designed to allow the use of MV/DX data through OPC-compatible client software (e.g., SCADA software, VB). See Bulletin 04L01B03-00E for detailed information on DAQOPC.

## Three-mode power supply

In addition to 100 VAC and 200 VAC powered models, MobileCorder is also available in DC powered models and with a rechargeable battery (MV100 only).

### • DC powered model (specify when placing order)

When this model is ordered, the main unit is designed specifically for DC power.



The power inlet is modified.

An AC adapter is included as a standard accessory so that AC power can also be used.

### • Rechargeable battery model (specify when placing order; MV100 only)

This model contains a rechargeable battery designed for up to 4 hours of continuous use. An AC adapter is included as a standard accessory so that AC power can also be used.

(Note: Maximum time for battery-powered operations varies according to usage conditions.)



When supplied with a rechargeable battery.

When supplied with an AC adapter.

## Function-specific specifications

■ Display unit  
Display: MV100: 5.5-inch TFT color LCD (320×240 dots)  
MV200: 10.4-inch TFT color LCD (640×480 dots)  
\* The LCD may contain some pixels that are either always on or always off. Due to the characteristics of liquid crystals, variations in brightness may occur. Please note that such variations do not mean the display is broken.

■ Power supply unit

MV100 power consumption

Supply voltage	With LCD saver on	Normal use	Maximum
100 VAC	Approximately 30 VA	Approximately 32 VA	Approximately 45 VA
240 VAC	Approximately 42 VA	Approximately 47 VA	Approximately 62 VA
12 VDC	Approximately 12 VA	Approximately 14 VA	Approximately 30 VA

MV200 power consumption

Supply voltage	With LCD saver on	Normal use	Maximum
100 VAC	Approximately 53 VA	Approximately 53 VA	Approximately 75 VA
240 VAC	Approximately 78 VA	Approximately 80 VA	Approximately 106 VA
120 VDC	Approximately 19 VA	Approximately 21 A	Approximately 42 VA

## Common standard specifications

■ General specifications

■ Structure  
MV100 external dimensions: Approximately 152 (W)×225 (H)×240 (D) mm  
MV100 weight: Approximately 4 kg  
MV200 external dimensions: Approximately 281 (W)×338 (H)×252 (D) mm  
MV200 weight: Approximately 7 kg

■ Input unit  
Input types: Floating unbalanced input, inter-channel isolation (However, a common terminal is used for RTDs.)  
Measurement intervals: MV102, MV104, MV204, MV208: 125 ms  
MV106, MV112, MV210, MV220, MV230: 1 second (Measurement interval is 2 seconds when the A/D integrating time is set to 100 ms.)

Input ranges, measuring ranges, and measurement/display accuracy: (reference operating conditions: 23 ±2°C; 55 ±10% RH; supply voltage: 90 to 132, 180 to 250 VAC; supply frequency: 50/60 Hz ±1%; warmup time: 30 minutes or longer; performance under conditions, such as vibrations, which do not affect equipment operations)

Input	Range/Type	Measuring range	Measurement accuracy (digital display)	Digital display maximum resolution
DCV	20 mV	-20.00 to 20.00 mV	±(0.1% of rdg + 2 digits)	10 μV
	60 mV	-60.00 to 60.00 mV		10 μV
	200 mV	-200.00 to 200.00 mV		100 μV
	2 V	-2.000 to 2.000 V		1 mV
	6 V	-6.000 to 6.000 V		1 mV
	20 V	-20.00 to 20.00 V		10 mV
TC	R*1	0.0 to 1760.0°C / 32 to 3200°F	±(0.15% of rdg + 1°C)	0.1°C
	S*1	0.0 to 1760.0°C / 32 to 3200°F	R, S: 0 to 100°C, ±3.7°C; 100 to 300°C, ±1.5°C; B: 400 to 600°C, ±2°C; if less than 400°C, accuracy is not guaranteed.	
	B*1	0.0 to 1820.0°C / 32 to 3200°F	±(0.15% of rdg + 0.7°C)	
	K*1	-200.0 to 1370.0°C / -328 to 2498°F	±(0.15% of rdg + 1°C)	
	E*1	-200.0 to 800.0°C / -328.0 to 1472.0°F	±(0.15% of rdg + 0.5°C)	
	J*1	-200.0 to 1100.0°C / -328.0 to 2012.0°F	±(0.15% of rdg + 0.5°C)	
	T*1	-200.0 to 400.0°C / -328.0 to 752.0°F	If -200 to -100°C, then ±(0.15% of rdg + 0.7°C)	
	N*1	0.0 to 1300.0°C / 32 to 2372°F	±(0.15% of rdg + 0.7°C)	
	W*2	0.0 to 2315.0°C / -328.0 to 4199°F	±(0.15% of rdg + 1°C)	
	L*3	-200.0 to 900.0°C / -328.0 to 1652.0°F	±(0.15% of rdg + 0.5°C)	
	U*3	-200.0 to 400.0°C / -328.0 to 752.0°F	If -200 to -100°C, then ±(0.15% of rdg + 0.7°C)	
	RTD*5	Pt100*4	-200.0 to 600.0°C	
JPt100*4		-200.0 to 550.0°C		
DI	Voltage input	OFF: Less than 2.4 V ON: 2.4 V or greater		
	Contact input	Contact ON/OFF		

\*1 R, S, B, K, E, J, T, N: IEC584-1 (1995), DIN IEC584, JIS C 1602-1995  
\*2 W: W-5%, Rd/W-26%, Rd (Hoskins Mfg. Co.) ASTM E988  
\*3 L: Fe-CuNi, DIN43710, U: Cu-CuNi, DIN43710  
\*4 Pt100: JIS C 1604-1997, IEC751-1995, DIN IEC751-1996, JPt100: JIS C 1604-1989, JIS C 1606-1989  
\*5 Measuring current: I = 1 mA

A/D integration time: Select from 20 ms (50 Hz), 16.7 ms (60 Hz), 100 ms (MV106, MV112, MV210, MV220, and MV230 only), and AUTO (automatic switching between 20 ms and 16.7 ms according to power frequency). When using 12VDC power or the MV100 battery pack, 20 ms is always used as the integration time (no automatic switching).

Reference junction compensation (RJC): INT (internal)/EXT (external) switching possible  
Type R, S, B, W: ±1°C  
Type K, J, E, T, N, L, U: ±0.5°C (when measured at 0°C or higher)

RJC accuracy: 2 VDC or lower voltage range and thermocouple: ±10 VDC (continuous)  
6 V, 20 V, 50 VDC voltage range: ±60 VDC (continuous)  
2 VDC or lower voltage range and thermocouple: 10 MΩ or greater  
6 V, 20 V, 50 VDC voltage range: Approximately 1 MΩ

Input resistance: DC voltage, thermocouple input: 2 kΩ or less  
RTD input: 10 Ω or less per line (equal on all three lines)

Input external resistance: 10 nA or less

Input bias current: 250 VAC rms (50/60 Hz)  
Maximum common mode noise voltage: 120 dB (50/60 Hz ±0.1%; 500Ω unbalanced; negative terminal to ground)

Normal mode rejection ratio: 40 dB (50/60 Hz±0.1%)  
Thermocouple burnout: Sensor ON/OFF switching possible  
Burnout upscale/downscale switching possible

Calculation: Difference calculation: Difference calculation between any channels  
Difference calculation range: DCV, TC, RTD  
Linear scaling: Scaling range: DCV, TC, RTD  
Scalable value: -30000 to 30000  
Square root scaling: Scaling range: DCV  
Scalable value: -30000 to 30000

■ Display unit  
Display colors: Trend and bar graph displays: 12 colors for MV100, 16 colors for MV200  
Background: White or black  
Trend display: Direction: Vertical or horizontal  
Number of windows: Switching between 4 (4 groups)  
Thickness: 1, 2, or 3 dots  
Waveform update rate: 15 or 30 seconds (125-ms measurement interval model only), 1, 2, 5, 10, 20, or 30 minutes, or 1, 2, 4 hours (per div)

Bar graph display: Direction: Vertical or horizontal  
Number of windows: Switching between 4 (4 groups)  
Scale: Can be set in range of 4 to 12.  
Horizontal bar graph reference position: End or center  
Update rate: 1 second

Digital display: Update rate: 1 second  
Overview display: Measurement values and alarm statuses on all channels  
Information display: Alarm summary, message summary, memory information, media information, etc.

Other displayed information: Memory status, scale values (0, 100%, center scale display ON/OFF switching capability)  
Grid (AUTO grid setting, or set number of segments between 4 and 12) and hours : minutes  
Time (year / month / date, hours : minutes : seconds), Trip line (thickness: 1, 2, or 3 dots), Messages (maximum 16 characters, up to 8 types), alarm marks

Data reference function: Data can be played back from internal memory or a removable storage medium.  
Display types: Split screen (divided in 2) or whole screen  
Time axis operations: Zoom-in/-out display, scrolling

■ Storage functions  
Removable storage drive: A drive for the following types of media can be selected when you place your order:  
• 3.5-inch floppy disk (2HD)  
• Zip disk  
• CompactFlash memory card

Data saving method: Manual saving or auto-saving  
Manual saving: Saves data when a removable storage medium is inserted.  
Auto-saving: Saves display data: Saves data to a removable storage medium periodically (every 10 minutes to 31 days); Saving event data: Saves data to a removable storage medium periodically (every 3 minutes to 31 days) (when trigger is not yet specified) Or saves data when sampling period ends (when trigger is specified).

Auto-saving at set times: This function automatically saves data at times set in advance. It is used together with the auto-save period setting.

Data saving intervals: Display data files: Interval varies according to the waveform update rate.  
Event data files: Sampling interval is specified.

Event data file sampling intervals: MV102, MV104, MV204, NV208: 125, 250, 500 ms, 1, 2, 5, 10, 30, 60, 120, 300 or 600 seconds  
MV106, MV112, MV210, MV220, MV230: 1, 2, 5, 10, 30, 60, 120, 300 or 600 seconds

Measurement data files: The following two types of files can be created:  
(1) Event data files (to save instantaneous values sampled at specified sampling intervals)  
(2) Display data files (to save maximum and minimum values occurring in display update interval in measurement data sampled at measurement interval)

The two file types can be combined as follows:  
(1) Event data file (trigger only) plus display data file  
(2) Display data file only  
(3) Event data file only

Data format: Yokogawa standard format (binary format)

Per-channel data: Display data: Measurement data: 4 bytes per data  
Calculation data: 8 bytes per data  
Event data: Measurement data: 2 bytes per data  
Calculation data: 4 bytes per data

Sampling time: Example sampling times (MV106, 6 measurement channels, 0 calculation channels)

**Display data file only**

Display updating (min/div)	1 minute	5 minutes	20 minutes	30 minutes	60 minutes	240 minutes
Saving interval (seconds)	2 seconds	10 seconds	40 seconds	60 seconds	120 seconds	480 seconds
Sampling time	Approximately 27 hours	Approximately 5 days	Approximately 23 days	Approximately 34 days	Approximately 69 days	Approximately 277 days

**Event data file only**

Saving interval	1 second	5 seconds	10 seconds	30 seconds	60 seconds	120 seconds
Sampling time	Approximately 27 hours	Approximately 5 days	Approximately 11 days	Approximately 34 days	Approximately 69 days	Approximately 138 days

**Display data file plus event data file**

Display updating (min/div)	1 minute	5 minutes	20 minutes	30 minutes	60 minutes	240 minutes
Saving interval (seconds)	2 seconds	10 seconds	40 seconds	60 seconds	120 seconds	480 seconds
Sampling time	Approximately 20 hours	Approximately 4 days	Approximately 17 days	Approximately 26 days	Approximately 52 days	Approximately 208 days

**Event data file**

Saving interval	1 second	5 seconds	10 seconds	30 seconds	60 seconds	120 seconds
Sampling time	Approximately 6.9 hours	Approximately 34 hours	Approximately 2 days	Approximately 8 days	Approximately 17 days	Approximately 34 days

**Manual sampling data:** Storage trigger: Key input or contact input  
Data format: ASCII format  
Maximum stored data: 50 data

**TLOG data (with calculation option only):** Time series integrated (totalized) value, maximum value, minimum value, average value, max-min value  
Storage trigger: Data saved when TLOG time is up.

**Report data (with calculation option only):** Periodic average value, maximum value, minimum value, and integrated (totalized) value.  
Types: Hourly reports, daily reports, hourly + daily reports, daily + weekly reports, daily + monthly reports  
Data format: ASCII  
Copying method: Key input  
Data format: PNG  
Output to: Removable storage medium or online output

- **Trigger functions**  
Event data file: Select FREE, TRIG, or ROTATE mode.  
Display data + event data file: Select TRIG or ROTATE mode.  
Trigger source: Key input, remote control (optional), alarm  
Pretrigger: Works with event data. 0, 5, 25, 50, 75, 95, or 100%
- **Alarm functions**  
Maximum number: A maximum of four alarms can be set on each channel.  
Alarm types: High-low limits, High-low difference limits, rate-of-change increase/decrease limits, delay upper/lower limits (alarm delay)  
Rate-of-change alarm time interval: Measurement interval x 1 to 15  
Display: Status (alarm type) and common alarm display in digital display area when alarm occurs  
Hold/no hold switching capability  
Hysteresis: ON (0.5% of display span)/OFF switching (common to all channels/levels)  
Outputs: 2, 4, 6, 12, or 24 (12 and 24 can be specified for MV200 only)  
Operation excitation/no excitation, hold/no hold switching capability  
Storage: Stored information: Alarm occurrence/clear time, alarm type  
Number of saved items: Maximum 120 (most recent)
- **Communication functions**  
Network type: Ethernet (10BASE-T)  
Basic protocol: SMTP, HTTP, FTP, TCP, UDP, IP, ARP, ICMP  
File transfer function: Automatic transfer from MV100/MV200 (FTP client protocol)  
File transfer in response to request from host computer (FTP server protocol)  
Real time monitor function: Real time online monitoring of MV100/MV200 measurement data (proprietary protocol)  
Transferable files: Display data files, event data files, report data, and screenshot data  
FTP server functions: Directory operations on a removable storage medium, file output, file deletion, and information on available memory space in a storage medium  
Web server function: Complies with HTTP 1.0. Displays the MV screen image on a Web browser (Internet Explorer 5.0/5.5). This function has a monitor-only mode as well as a mode that allows access to screen controls. Separate passwords can be set for each mode. The function also allows messages to be changed/written.  
E-mail function: This function automatically sends an e-mail message when any of the following events occur: alarm, power restoration, full memory, storage media error, set time, report time-out (/M1). E-mails can be addressed to as many as two groups (maximum 150 characters per group).

- **Power supply unit**  
● AC power supply  
Rated supply voltage: 100 to 240 VAC (automatic switching)  
Operating supply voltage range: 90 to 250 VAC  
Rated supply frequency: 50/60 Hz (automatic switching)  
● DC power supply  
Rated supply voltage: 12 VDC  
Operating supply voltage range: 10 to 18 VDC  
● Rechargeable battery model (MV100 only)  
Operation: Powered by special AC adapter or special battery pack.  
● The special Ni-MH battery pack can only be charged inside the MV100.  
● If both the AC adapter and battery pack are connected, the AC adapter will be used.  
Special Ni-MH battery pack  
4200 mAh, 7.2V  
Number of recharges (cycle life): Approximately 300 (depends on usage environment)  
Special battery pack charging function: The battery pack can be fully charged in approximately 2.5 hours in quick-charge mode when the special AC adapter is connected to the MV100 with the MV power off. If the power is on, the battery pack will be trickle-charged.  
Special battery pack continuous operation time: 4 hours maximum (room temperature), under the following conditions. Alarm output relay: Non-excited. LCD brightness: 1. Back-

- **Other features:**  
Clock: Calendar feature (Western calendar) included; time can be set through external contact (remote control option)  
Saves settings using internal lithium battery (service life: approximately 10 years at room temperature).  
Memory backup: Can be turned on and off. Password can also be set for this function.  
Key lock function: With this function, the system boots in logoff mode when the power turns on, and all controls are disabled. (Measurements are performed.) Users can login to operation mode by entering a user name, user ID, and password.  
Key login function: 20 MΩ or higher (each terminal to ground terminal) (at 500 VDC)  
Insulation resistance: 1500 VAC (50/60 Hz), for one minute (except when using 12 VDC power)  
Power terminal to ground terminal: 500 VAC (50/60 Hz), for one minute (when using 12 VDC power)  
Contact output terminal to ground terminal: 1500 VAC (50/60 Hz), for one minute  
Measurement input terminal to ground terminal: 1500 VAC (50/60 Hz), for one minute  
Between measurement input terminals: 1000 VAC (50/60 Hz), for one minute (excludes MV106, MV112, MV210, MV220, and MV230 RTD inputs because the b terminal is the common terminal on these models)  
Remote control terminal to ground terminal: 500 VDC, for one minute

**Normal operating conditions**

Supply voltage: AC power supply: 90 to 132, 180 to 250 VAC  
DC power supply: 10 to 18 VDC  
Supply frequency: 50 Hz ±2%, 60 Hz ±2%  
Ambient temperature: 5 to 40°C  
Ambient humidity: 20 to 80% RH (at 5 to 40°C)

**Optional specifications**

- **Alarm output relay contacts (/A1, /A2, /A3, /A4, /A5)/(/A4 and /A5 can be specified for MV200 only)**  
Relay output from back side when alarm occurs.  
Number of outputs: 2, 4, 6, 12, or 24 (12 and 24 can be specified for MV200 only)  
Relay contact capacitance: 250 VDC/0.1 A (resistance load), 250 VAC (50/60 Hz)/3 A  
Output form: NO-C-NC (excitation/no excitation, AND/OR, hold/no hold switching capability)
- **Serial communications (/C2, /C3)**  
Host computer remote control, setting, and data output to host capability  
Interface type: EIA RS-232 (/C2) or RS-422-A/485 (4-wire) (/C3) compliance  
Protocol: Proprietary protocol  
Synchronization method: Start-stop  
Communication type (RS-422-A/485): 4-wire half-duplex multidrop connection (1-N (where N is 1 to 31))  
Transfer rate: 1200, 2400, 4800, 9600, 19200, 38400 bps  
Data length: 7 or 8 bits  
Stop bit: 1 bit  
Parity: Odd, even, none  
Maximum distance (RS-422-A/485): 500 meters  
Communication modes: ASCII mode for control and settings I/O. ASCII or binary mode for measurement data output.  
Operating modes: RTU SLAVE, RTU MASTER. Option /M1 is required when using RTU MASTER.  
data reading, data writing  
Connection method: 4-wire (for RS-422-A/485)
- **VGA output terminal (/D5) MV200 only**  
Enables connection to external display device.  
Resolution: 480 x 640 dots (VGA specifications)  
Connector: 15-pin D-SUB
- **FAIL/memory end output (/F1)**  
Relay output is performed through the back side during manual saving when a system error occurs, or a specified number of hours before display data file overwriting starts (select from 1, 2, 5, 10, 20, 50, 100 hours). During auto-saving, relay output is performed when the removable storage medium free capacity falls to 10%.  
Relay contact capacitance: 250VDC/0.1A (resistance load), 250VAC (50/60Hz)/3A
- **Screw input terminals (/H3) (option for MV100 only; specified by a suffix code for MV200)**  
The input terminals are screw terminals.
- **Mathematical calculation functions (/M1)**  
The MV100/MV200 is capable of the following calculations, as well as calculation channel trends/digital displaying and recording.  
Calculation channels: MV102, MV104: 8 channels  
MV106, MV112: 12 channels  
MV204, MV208: 8 channels  
MV210, MV220, MV230: 30 channels
- **Calculation types:** General calculations: Addition, subtraction, multiplication, division, square root, absolute value, common logarithm, exponent, power, relationships (<, >, =, ≠, =, ≠), logical calculations (AND, OR, NOT, XOR)  
Statistical calculations: Time series data average, maximum, minimum, and integrated (totalized) values
- **Constants:** Up to 12 constants can be set for MV100, 30 for MV200.
- **Communication digital input:** Up to 12 (data) for MV100, 30 (data) for MV200 communication digital inputs are allowed. Can be used for calculation equations other than statistics.
- **Remote input:** Up to 8 remote inputs are allowed. Remote status (0/1) can be used in calculation equations.
- **Report functions:** Report types: Hourly reports, daily reports, hourly + daily reports, daily + weekly reports, daily + monthly reports  
Calculation types: Average, maximum, minimum, and integrated (totalized) values  
Data format: ASCII
- **Cu10/Cu25 RTD input/3-wire isolated RTD input (/N1)**  
This option enables Cu10 and Cu25 inputs in addition to the standard inputs. With MV106, MV112, MV210, MV220, and MV230, all input points are isolated (A, B, and b are all isolated).

- **3-wire isolated RTD input (/N2)**  
With this option, all RTD input points are isolated (A, B, and b are all isolated).  
\* Only available with MV106, MV112, MV210, MV220, and MV230. MV102, MV104, MV204, and MV208 come standard with A, B, and b isolated.
- **Remote control (/R1)**  
The following remote control operations are possible through contact input (up to eight can be set).  
● Memory start/stop (level)  
● Event data file external trigger input (trigger, 250 ms or greater)  
● Time adjustment (adjusts time to reference time using contact; trigger, 250 ms or greater)  
● Calculation start/stop (level)  
● Calculation data reset (trigger, 250 ms or greater)  
● Manual sampling (trigger, 250 ms or greater)  
● Message writing (as many as 8 can be set; trigger, 250 ms or greater)  
● Load settings (as many as 3 can be set; trigger, 250 ms or greater)  
● Alarm ACK (trigger, 250 ms or greater)  
● Snapshot (trigger, 250ms or greater)
- **24VDC transmitter power supply (/TPS\*)**  
Loops: /TPS2: 2 loops; /TPS4: 4 loops; /TPS8: 8 loops  
Output voltage: 22.8 to 25.2VDC (for rated current load)  
Rated output current: 4 to 20mA DC  
Maximum output current: 25mA DC (overcurrent protection operation current: approximately 68mA DC)  
Allowed conductor resistance: RL ≤ (17.8 - transmitter minimum operating voltage)/0.02 A (load shunt resistance 250Ω; drop voltage not included)  
2 km (using CEV cable)  
Maximum wire length: Between output terminal and main unit ground: 20 MΩ or greater (500VDC)  
Insulation resistance: Between output terminals: 500VAC (50/60Hz, i = 10 mA), for one minute  
Withstand voltage: Between output terminal and main unit ground: 500 VAC (50/60Hz, i = 10 mA), for one minute

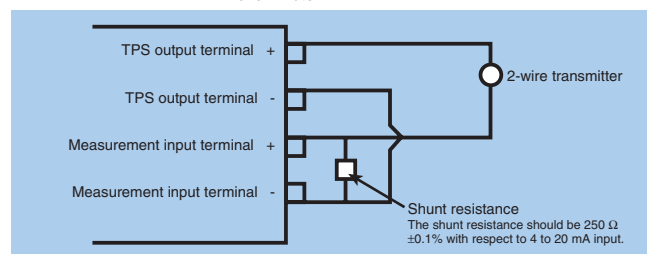

**Application software**

- **DAQSTANDARD (standard with MV100/MV200) and DAQEXPLORER (separately sold software) common specifications**  
System requirements  
OS: Microsoft Windows 98/Me/NT4.0/2000/XP  
Processor: MMX Pentium 166 MHz or higher (Pentium II 266 MHz or higher recommended)  
Disk drive: CD-ROM drive  
Free hard drive space: 10 MB or more (100 MB recommended)  
Display card: Display card capable of displaying 32,000 colors or more (64,000 or more recommended) and compatible with Windows 98/Me/NT4.0/2000/XP  
Printer: Printer and printer driver compatible with Windows 98/Me/NT4.0/2000/XP  
● **DAQSTANDARD**  
RAM: 32 MB or more (64 MB recommended)  
Main functions (package): Hardware configurations (online or using a removable storage medium)  
Data viewer (waveform playback)  
Printout of playback data  
File conversion (to ASCII, Lotus 1-2-3, and MS-Excel formats)  
● **DAQEXPLORER**  
RAM: 64 MB or more (128 MB recommended)  
Main functions (package): Desktop (file transfers, configurations, etc. using operations on desktop)  
Data monitoring  
Hardware configurations (online or using a removable storage medium)  
Data viewer  
Printout of playback data  
File conversion (to ASCII, Lotus 1-2-3, and MS-Excel formats)
- **DAQLOGGER (separately sold software)**  
PC: PC running Microsoft Windows 98/NT4.0 (Service Pack 3 or later), or Windows 2000, Windows XP or later\*\*, with:  
An MMX Pentium 166 MHz or faster processor (Pentium II 300 MHz or faster recommended) and at least 64 MB of RAM (128 MB or more recommended) is required to run the 400-channel model of DAQLOGGER.  
A Pentium II 300 MHz or faster (Pentium III 400 MHz or faster recommended) and at least 128 MB of RAM (256 MB or more recommended) is required to run the 1000-channel model of DAQLOGGER.  
A Pentium III 400 MHz or faster (Pentium III 600 MHz or faster recommended) and at least 128 MB of RAM (256 MB or more recommended) is required to run the 1600-channel model of DAQLOGGER.  
Hard disk: At least 30 MB of free space is required when installing the software. (The free hard disk space needed for data storage depends on the amount of data to be stored.)  
At least 800 x 600 resolution; 32,768 colors (1024 x 768 recommended)  
Display: A CD-ROM drive supported by your Windows operating system is required for installing the software.  
CD-ROM drive: RS-232-C ports supported by your Windows operating system (the COM1 to COM9 ports can be used).  
Communication interface: Ethernet port (when connecting DX, DARWIN or MV via Ethernet)  
Printer and pointing device: A mouse supported by your Windows operating system is required. A printer supported by your Windows operating system is required for printing.

\*\* Windows 2000 is recommended as the operating system for DAQLOGGER. If DAQLOGGER is run under Windows 95 or Windows 98, it is more likely to fail to acquire some data during scanning due to the nature of these operating systems, in comparison to Windows NT4.0 or Windows 2000. If you experience this type of problem, increase the measurement scan interval as needed.

- **Operating Conditions**  
Data acquisition/recording products supported by DAQLOGGER:  
MV100, MV200, μR1000, μR1800, VR100, VR200, DX100, DX200, DA100, DC100, DR130, DR231, DR232, DR241, DR242  
Option required for μR and VR Series: RS-422-A/485 port  
Option required for MV and DX Series: RS-422-A/485 port, RS-232-C, or Ethernet port  
Option required for DARWIN Series: RS-422-A/485 port, RS-232-C, or Ethernet module needs to be installed or one of those optional ports needs to be included.

**Models and applicable communication methods**

	μR1000	μR1800	VR100	VR200	MV100	MV200	DX100	DX200	DR240	DR230	DR130	DC100	DA100
RS-422-A	✓	✓	✓	✓	✓	✓	✓	✓	✓	✓	✓	✓	✓
RS-232-C					✓	✓	✓	✓	✓	✓	✓	✓	✓
Ethernet					✓	✓	✓	✓	✓	✓	✓	✓	✓

**Other devices needed:** An RS-232-C/RS-422-A/RS-485 converter is required when connecting recorders using their RS-422-A/485 ports. (For the recommended model, contact the nearest sales representative.)  
**Connectable number of recorders:** 32 maximum (mixture of above models allowed).  
**Maximum number of channels:** 400, 1000, or 1600 depending on the model of DAQLOGGER  
**Shortest data acquisition interval:** 1 second can be set though this depends on the system configuration (such factors as the PC's performance, number and types of connected recorders, and baud rate). Note that alarms occurring or cleared within a period shorter than the data acquisition interval cannot be detected.  
**Channel control:** Implemented by grouping (up to 50 groups, each of which can contain up to 32 channels)

**External view**

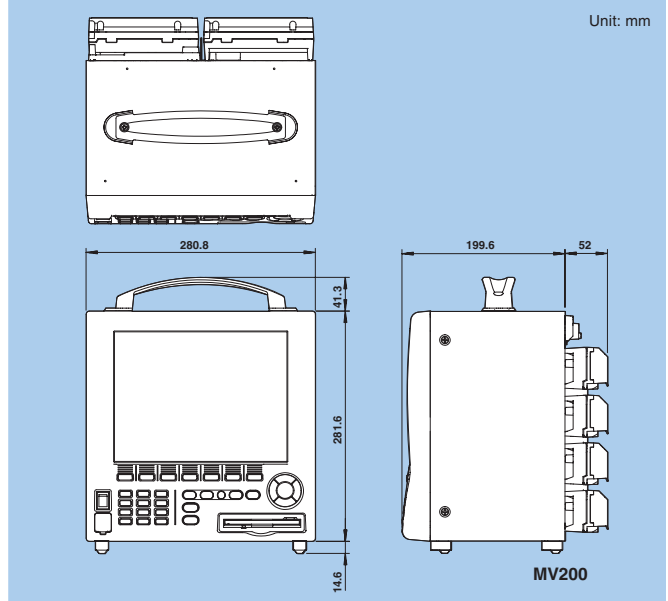
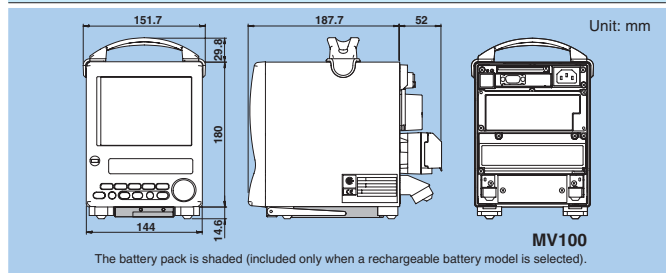



## Model and Suffix Codes

### MV100

Model	Suffix Code	Option Code	Description
MV102			MobileCorder MV100 (2 channels) (125-ms measurement interval, clamp terminal)
MV104			MobileCorder MV100 (4 channels) (125-ms measurement interval, clamp terminal)
MV106			MobileCorder MV100 (6 channels) (1-sec measurement interval, clamp terminal)
MV112			MobileCorder MV100 (12 channels) (1-sec measurement interval, clamp terminal)
Removable storage drive/slot	-1		Floppy disk drive
	-3		CompactFlash memory card (CF + Adapter)
	-5		Zip drive (with medium, 250 MB)
Display/software language	-2		English, German and French, deg F/summer & winter time (with English DAQSTANDARD)
Power supply	-1		100 or 240 VAC
	-2		12 VDC*1*8
	-3		Rechargeable battery *1
Power inlet, power cord	D	F	3-pin power inlet with UL/CSA cable
		F	3-pin power inlet with VDE cable
		R	3-pin power inlet with SAA cable
		S	3-pin power inlet with BS cable
Options	/A1		Alarm output 2 points*2*6*7
	/A2		Alarm output 4 points*2*6*7
	/A3		Alarm output 6 points*2*3*6*7
	/C2		RS-232 interface*4*9
	/C3		RS-422-A/485 interface*4*9
	/F1		Fail/memory end detection output *3*6*7
	/H3		Screw terminal (M4)
	/M1		Mathematical function (including report function)*9
	/N1		Cu10, Cu25 RTD input/3leg isolated RTD
	/N2		3leg isolated RTD*5
	/R1		Remote control
	/TPS2		24 VDC transmitter power supply (2 loops) *6*7*8
/TPS4		24 VDC transmitter power supply (4 loops) *6*7*8	

\*1 An AC adapter is included as a standard accessory.  
 \*2 Only one from the /A1, /A2, and /A3 options can be specified.  
 \*3 The /A3 and /F1 options cannot be specified at the same time.  
 \*4 The /C2 and /C3 options cannot be specified at the same time.  
 \*5 The /N2 option can be specified for the MV106 and MV112 only.  
 \*6 The /TPS4, /A2, /A3, and /F1 options cannot be selected if the /TPS2 option is selected.  
 \*7 The /TPS2, /A1, /A2, /A3, and /F1 options cannot be selected if the /TPS4 option is selected.  
 \*8 The /TPS2 and /TPS4 options cannot be selected if a 12VDC power supply is selected.  
 \*9 /M1 is required when using Modbus master function of /C2 or /C3.

### MV200

Model	Suffix Code	Option Code	Description
MV204			MobileCorder MV200 (4 channels) (125-ms measurement interval)
MV208			MobileCorder MV200 (8 channels) (125-ms measurement interval)
MV210			MobileCorder MV200 (10 channels) (1-sec measurement interval)
MV220			MobileCorder MV200 (20 channels) (1-sec measurement interval)
MV230			MobileCorder MV200 (30 channels) (1-sec measurement interval)
Removable storage drive/slot	-1		Floppy disk drive
	-3		CompactFlash memory card (CF + Adapter)
	-5		Zip drive (with medium, 250 MB)
Display/software language	-2		English, German and French, deg F/summer&winter time (with English DAQSTANDARD)
Input terminal	-1		Clamp terminal
		-2	
Power supply	-1		100 VAC or 240VAC
		-2	
Power inlet, power cord	D	F	3-Pin Power Inlet with UL/CSA cable
		F	3-Pin Power Inlet with VDE cable
		R	3-Pin Power Inlet with SAA cable
		S	3-Pin Power Inlet with BS cable
Options	/A1		Alarm output 2 points *2
	/A2		Alarm output 4 points *2
	/A3		Alarm output 6 points *2
	/A4		Alarm output 12 points *2, *7
	/A5		Alarm output 24 points *2, *3, *6
	/C2		RS-232 interface *4*9
	/C3		RS-422-A/485 interface *4*9
	/D5		VGA video output
	/F1		FAIL/memory end detection output *3,*7
	/M1		Mathematical function (with report function)*9
	/N1		Cu10, Cu25 RTD input/3leg isolated RTD
	/N2		3leg isolated RTD *5
/R1		Remote control	
/TPS4		24 VDC transmitter power supply (2 loops) *6*9	
/TPS8		24 VDC transmitter power supply (4 loops) *6*7*9	

\*1 An AC adapter is included as a standard accessory.  
 \*2 Only one of the /A1, /A2, /A3, /A4, and /A5 options can be specified.  
 \*3 The /A5 and /F1 options cannot be specified at the same time.  
 \*4 The /C2 and /C3 options cannot be specified at the same time.  
 \*5 The /N2 option can be specified for the MV210, MV220, and MV230 only.  
 \*6 Only one from the /TPS4, /TPS8, and /A5 options can be specified.  
 \*7 The /A4 and /F1 options cannot be selected at the same time if the /TPS8 option is selected.  
 \*8 The /TPS4 and /TPS8 options cannot be selected if a 12VDC power supply is selected.  
 \*9 /M1 is required when using Modbus master function of /C2 or /C3.

Either clamp terminals or screw terminals may be selected as the input terminal type. Note that the MV100 and MV200 have different input terminal specification methods.

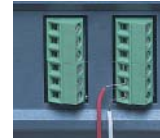

Clamp terminals



Screw terminals

## Accessories

### MV100 / MV200 Accessories (sold separately)

Model	Description
790501	Soft carrying case for MV100, front cover (790502) included
790502	Front cover for MV100
790511	Cover for MV200
790581	Module removal handle



790501



790511



790581

### Accessories (Sold separately)

Product	Product Model(part number)	Specification
Shunt resistor (for clamp terminal)	438920	250 Ω±0.1%
	438921	100 Ω±0.1%
	438922	10 Ω±0.1%
Shunt resistor (for screw terminal)	415920	250 Ω±0.1%
	415921	100 Ω±0.1%
	415922	10 Ω±0.1%
3.5inch floppy disk	705900	2HD (10 units)
Zip disk	A1053MP	100 MB
CompactFlash memory card (CF + Adapter)	B9968NL	32 MB or more

## Application Software

### Application Software

MODEL	Description	OS
DXA100-02	DAQSTANDARD(standard), English Version	Windows 2000/XP
WX101/CD1	DAQLOGGER (sold separately), English Version	Windows 2000/XP
WX104/CD1	DAQEXPLORER (sold separately), English Version	Windows 2000/XP
WX81/CD1	DAQLOGGER Client (sold separately), English Version	Windows 2000/XP
DXA410-01	DAQOPC (sold separately), English Version	Windows 2000/XP

The TCP/IP software used in this product and the documentation for that TCP/IP software are based in part on BSD Networking Software, Release 1 licensed from The Regents of the University of California.  
 Microsoft, MSN, and Windows are registered trademarks of Microsoft Corporation, USA.  
 Lotus and 1-2-3 are registered trademarks of Lotus Development Corporation.  
 MMX and Pentium are registered trademarks of Intel Corporation, USA.  
 Ethernet is a registered trademark of Xerox Corporation.  
 Zip and logo marks thereof are registered trademarks or trademarks of Iomega Corporation, USA.  
 Other company names and product names mentioned in this document are the registered trademarks or trademarks of their respective companies.

### NOTICE

- Before operating the product, read the instruction manual thoroughly for proper and safe operation.
- If this product is for use with a system requiring safeguards that directly involve personnel safety, please contact the Yokogawa sales offices.

**YOKOGAWA**

**YOKOGAWA ELECTRIC CORPORATION**

Network Solutions Business Div./Phone: (81)-422-52-7179, Fax: (81)-422-52-6619

E-mail: ns@cs.jp.yokogawa.com

**YOKOGAWA CORPORATION OF AMERICA**

**YOKOGAWA EUROPE B.V.**

**YOKOGAWA ENGINEERING ASIA PTE. LTD.**

Phone: 800-888-6400, Fax: (1)-770-251-6427

Phone: (31)-33-4641806, Fax: (31)-33-4641807

Phone: (65)-62419933, Fax: (65)-62412606

**NetSOL Online**

Sign up for our free e-mail newsletter  
[www.yokogawa.com/ns/](http://www.yokogawa.com/ns/)

Subject to change without notice.

[Ed : 06/b] Copyright ©2001

Printed in Japan, 602(KP)

RS-16E